

NIGHT BREAKER LED W5W

OSRAM's first NIGHT BREAKER W5W LED for use in all1) 12V vehicle models behind white glass



Universal Polarity & Plug and Play

Installation independent of polarity possible. Quick and easy upgrade to LED technology with plug & play solution



Up to 5 times longer lifetime³⁾

Environmentally friendly and cost-efficient



4 Year OSRAM Guarantee⁴⁾

Systematic quality assurance measures underpin the premium workmanship and functionality of our products. Innovative technology and excellent quality really pay dividends for our customers.



Street-Legal¹⁾

The NIGHT BREAKER LED W5W - OSRAM's first LED retrofit lamp approved for all1) 12V vehicles in white light applications.

Product datasheet



An innovation and revolution from OSRAM in the field of technology and design.

With the NIGHT BREAKER W5W-LED, OSRAM's first street legal¹⁾ W5W-LED replacement lamp is now on the market, which is approved for use in all¹⁾ 12V vehicle models behind white glass as a parking light, position light, marker light, license plate light and interior light. This is the first lamp from OSRAM does not require to compare and match the headlamp approval number with a compatibility list. In combination with the NIGHT BREAKER H7-LED, H4-LED or H1-LED you can now get the full LED upgrade for your vehicle with perfectly tailored and designed LED lamps - for exterior and interior applications. These LED replacement lamps are suitable as a replacement for conventional W5W lamps and bases. They offer a modern and intense white light with a color temperature up to 5700 Kelvin and a light output of up to 50 lm. In comparison to standard lamps, these LED retrofit lamps consume up to 80% less energy. With the plug & play solution and the universal polarity they can be installed quickly and easily and regardless of polarity. You can now replace your vehicle lamps with OSRAM's revolutionary NIGHT BREAKER LED retrofit lamps and experience trend-setting brightness. Additionally, OSRAM offers a dedicated guarantee on all NIGHT BREAKER LED retrofit lamps²⁾In the very unlikely event of a failure message on your vehicle's dashboard, Osram also has also developed a solution for the NIGHT BREAKER LED W5W - the LEDriving Canbus Control Unit LED CCU01. Only the combination of OSRAM LED lamps in conjunction with the official OSRAM accessories - LEDriving ADAPTER, LEDriving SMART CANBUS, LEDriving CAPs and LEDriving ERROR CANCELER is approved for the operation of our LED lamps. Details, in particular on the combination of OSRAM accessories and the street-legal¹⁾ NIGHT BREAKER LED and TRUCKSTAR LED lamps, can be found on the respective product pages under: NIGHT BREAKER LED Kompatibilitätslisten | Automotive (osram.de).

Product datasheet

Technical data

Product information

Product legal advice 1	1)Approved LED light source - only applies to the respective countries in which there is approval or to which an equivalent approval applies and the vehicle models and light functions currently listed in the compatibility list. For more details see www.osram.com/nb-led
Product legal advice 2	2) For precise conditions please refer to: www.osram.com/am-guarantee
Order reference	2825DWNB
Application (Category and Product specific)	Position light, Interior light

Electrical data

Power input	1 W
Test voltage	13.2 V
Power input tolerance	±25 %
Nominal wattage	1.00 W
Nominal voltage	12.0 V

Photometrical data

Color temperature	5700 K
Luminous flux	50 lm
Luminous flux tolerance	±25 %
Light color LED	Cool white

Dimensions & weight

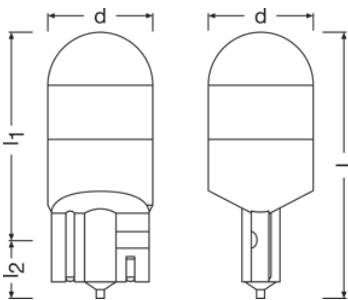

Product weight	1.70 g
Length	24.6 mm
Diameter	10.3 mm

Product datasheet

Lifespan

Lifespan Tc	3000 h
Lifespan B3	1500 h

Additional product data

Base (standard designation)	W2.1x9.5d
-----------------------------	-----------

Capabilities

Technology	LED
------------	-----

Certificates & standards

Standards	ABG
-----------	-----

Country specific categorizations

Order reference	2825DWNB
-----------------	----------

Environmental information

Information according Art. 33 of EU Regulation (EC) 1907/2006 (REACH)	
Date of Declaration	14-06-2024
Primary Article Identifier	4062172367448 4062172367424
Declaration No. in SCIP database	In work

Logistical Data

Product code	Product description	Packaging unit (Pieces/Unit)	Dimensions (length x width x height)	Volume	Gross weight
4062172367424	NIGHT BREAKER W5W LED	HFB 2	80 mm x 30 mm x 96 mm	0.23 dm ³	14.00 g
4062172367431	NIGHT BREAKER W5W LED	Shipping carton box 10	159 mm x 89 mm x 106 mm	1.50 dm ³	98.00 g

The mentioned product code describes the smallest quantity unit which can be ordered. One shipping unit can contain one or more single products. When placing an order, for the quantity please enter single or multiples of a shipping unit.

Download Data

File
 User instruction NIGHT BREAKER LED



Safety advice

Application advice: For more detailed application information and graphics please see product datasheet and user manual.

Legal advice

- 1) Approved LED light source applies to all vehicle models to specific light functions and further restrictions in the respective country. Must not be used behind red and/or yellow colored glass. For more details see www.osram.com/nb-led
- 2) In comparison to the minimum requirements of ECE R112
- 3) In comparison to traditional lamps
- 4) For precise conditions please refer to: www.osram.com/am-guarantee

Application advice

For more detailed application information and graphics please see product datasheet.

Disclaimer

Subject to change without notice. Errors and omission excepted. Always make sure to use the most recent release.

OSRAM